

SWITCHING DIODE

FEATURES:

- Four types of packaging are available
- High speed
- Suitable for high packing density layout
- High reliability
- **Pb-Free package is available**
RoHS product for packing code suffix "G"
Halogen free product for packing code suffix "H"
- **Moisture Sensitivity Level 1**

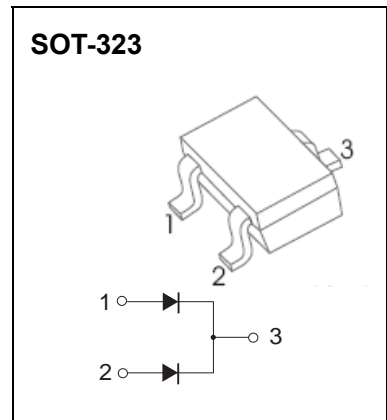

MARKING:N

Maximum Ratings and Electrical Characteristics, Single Diode @Ta=25 °C

Parameter	Symbol	Limit	Unit
Peak reverse voltage	V_{RM}	80	V
DC reverse voltage	V_R	80	V
Maximum (peak) forward current	I_{FM}	300	mA
Average forward current	I_O	100	mA
Power dissipation	P_D	200	mW
Junction temperature	T_j	150	°C
Operating/Storage temperature	T_{stg}	-55~+150	°C

ELECTRICAL CHARACTERISTICS (Ta=25°C unless otherwise specified)

Parameter	Symbol	Test conditions	Min	Max	Unit
Reverse breakdown voltage	$V_{(BR)}$	$I_R=100\mu A$	80		V
Reverse voltage leakage current	I_R	$V_R=70V$		0.1	μA
Forward voltage	V_F	$I_F=100mA$		1.2	V
Diode capacitance	C_D	$V_R=6V, f=1MHz$		3.5	pF
Reverse recovery time	t_{rr}	$V_R=6V, I_F=5mA$		4	ns



Typical Characteristics

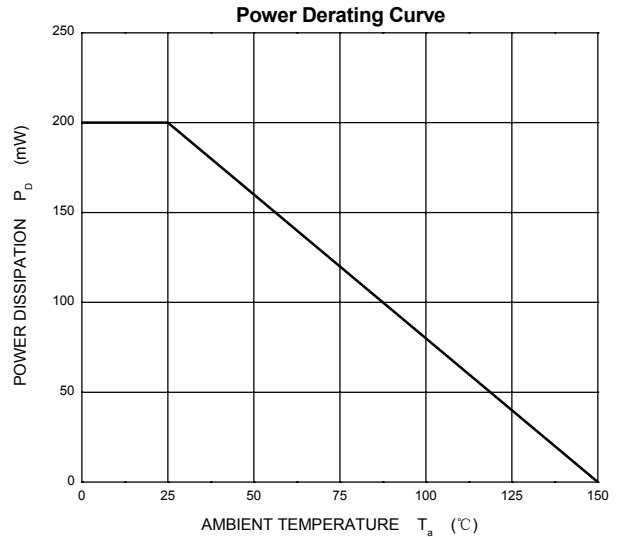
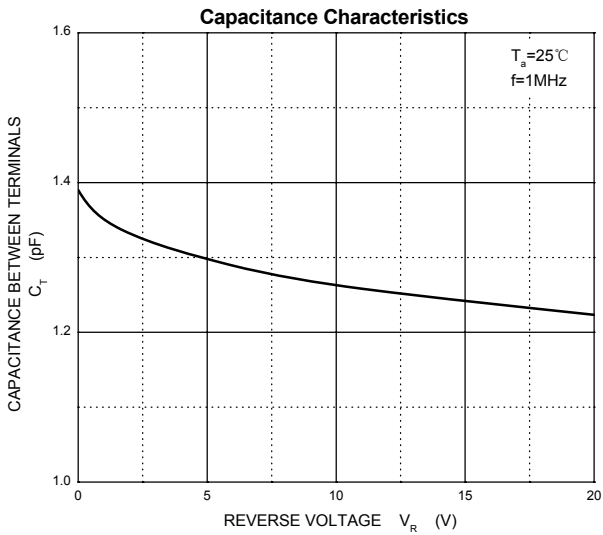
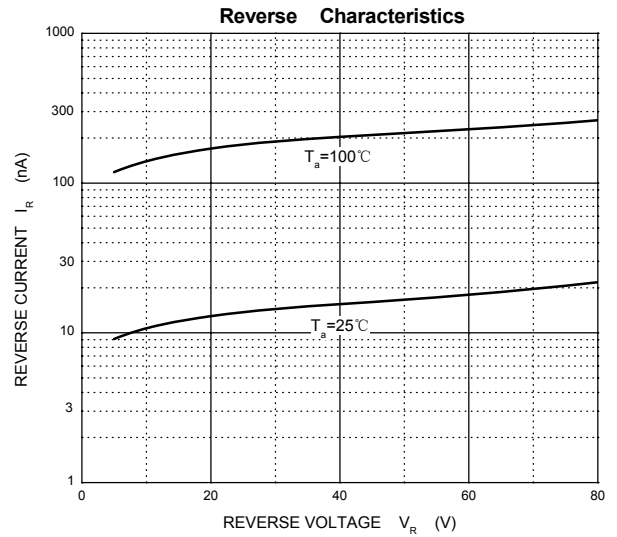
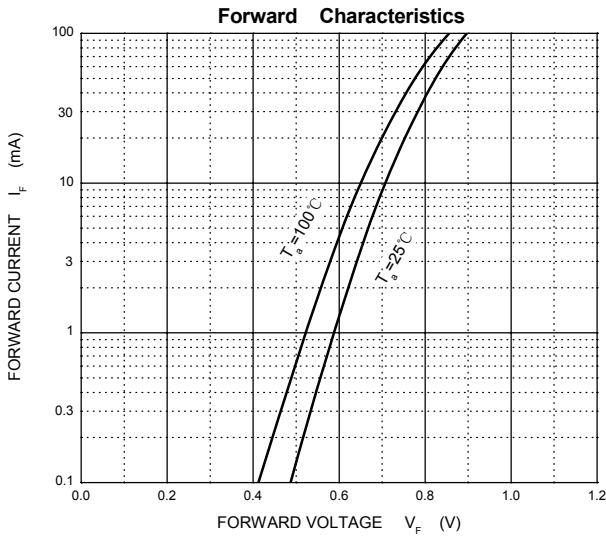



Outline Drawing

SOT-323

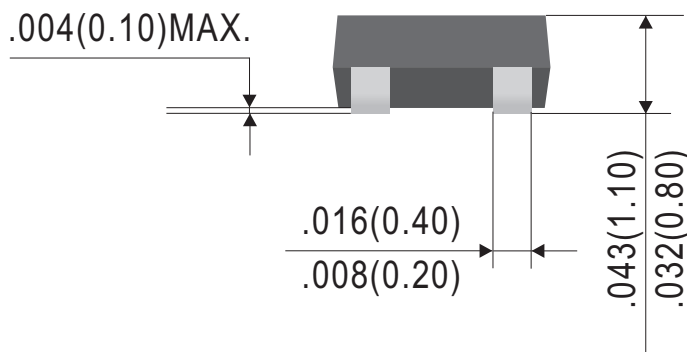
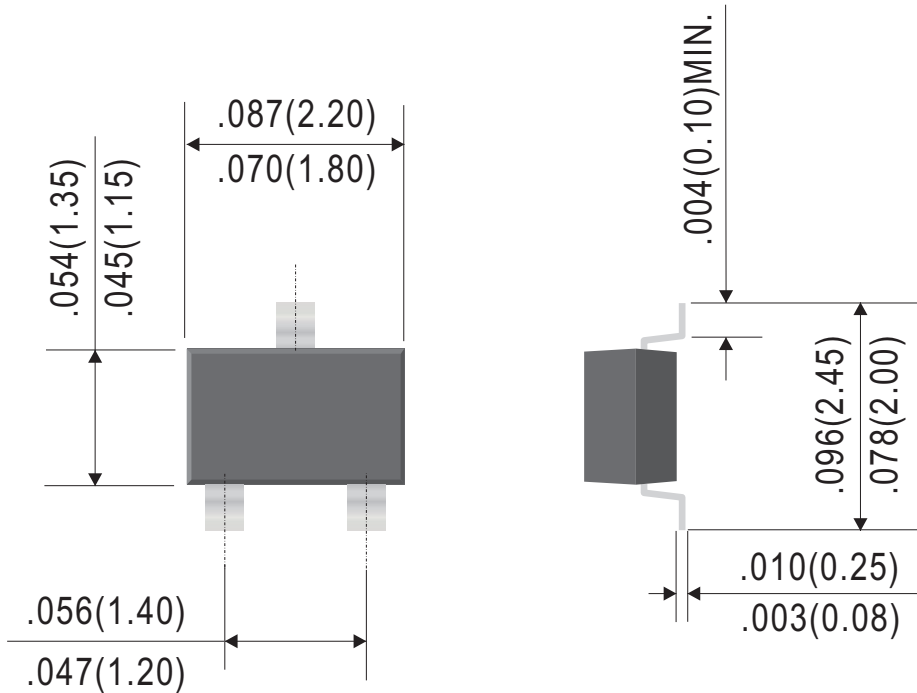

Dimensions in inches and (millimeters)

Ordering Information:

Device PN	Packing
DAN202U-T ⁽¹⁾ G ⁽²⁾ -WS	Tape&Reel: 3 Kpcs/Reel

Note: (1) Packing code, Tape&Reel Packing

(2) RoHS product for packing code suffix "G" ; Halogen free product for packing code suffix "H"

*****Disclaimer*****

WILLAS reserves the right to make changes without notice to any product specification herein, to make corrections, modifications, enhancements or other changes. WILLAS or anyone on its behalf assumes no responsibility or liability for any errors or inaccuracies. Data sheet specifications and its information contained are intended to provide a product description only. "Typical" parameters which may be included on WILLAS data sheets and/ or specifications can and do vary in different applications and actual performance may vary over time. WILLAS does not assume any liability arising out of the application or use of any product or circuit.

WILLAS products are not designed, intended or authorized for use in medical, life-saving implant or other applications intended for life-sustaining or other related applications where a failure or malfunction of component or circuitry may directly or indirectly cause injury or threaten a life without expressed written approval of WILLAS. Customers using or selling WILLAS components for use in such applications do so at their own risk and shall agree to fully indemnify WILLAS Inc and its subsidiaries harmless against all claims, damages and expenditures.